

Article number: 20192B40B40562SW

Description: E+G

T-angle clamps GN192-B40-B40-56-2-SW

Measures

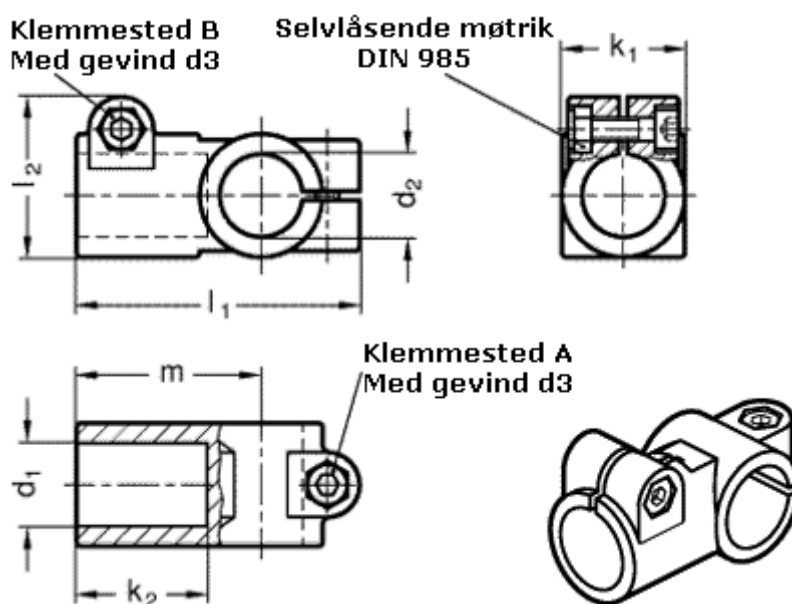

$d_1 = B40$

$d_2 = B40$

$d_3 = M10$

$k_1 = 56$

$k_2 = 62.0$

$l_1 = 129$

$l_2 = 69.0$

$m = 88$